

Ergotron® 200 Series

Dimensional Illustrations

Wall Mount Arm

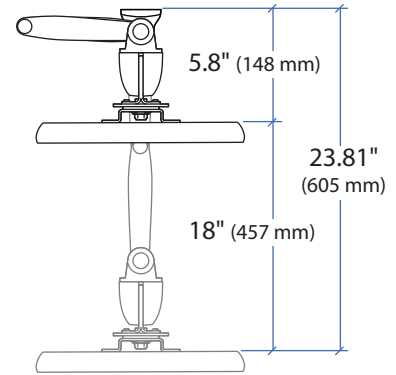
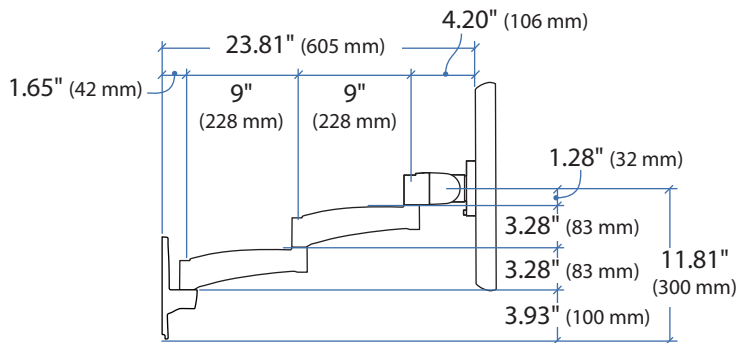

Top View

Wall Mount Bracket

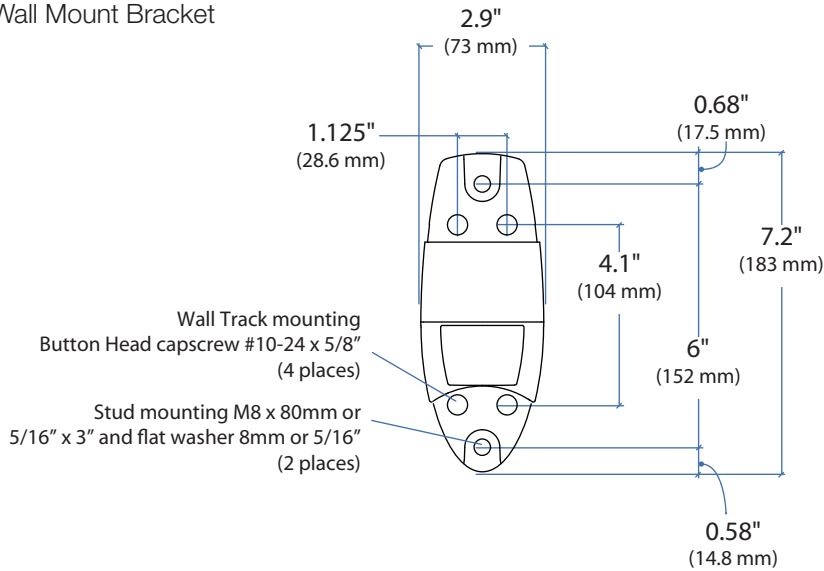

Range of Motion

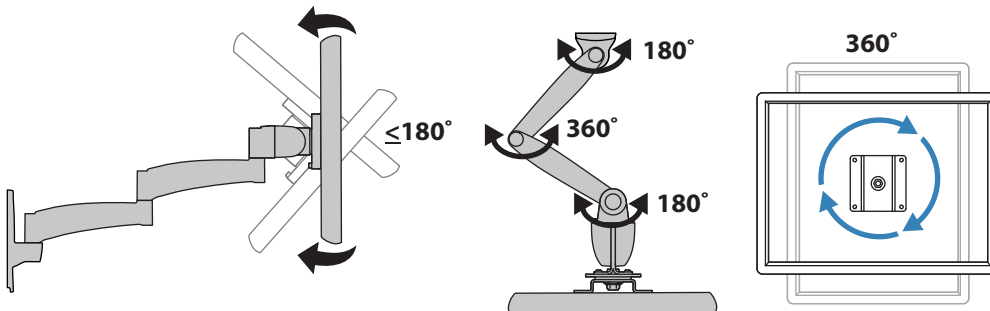

Maximum Weight Capacity

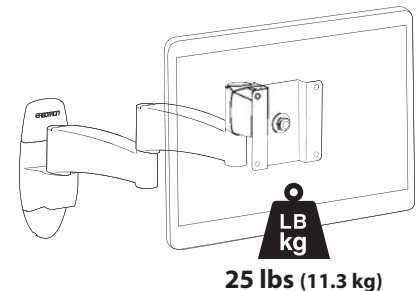

© 2010 Ergotron, Inc. rev. 02/10/2010 DIM-200 Arm2 Content is subject to change without notification

Americas Sales and Corporate Headquarters

St. Paul, MN USA
(800) 888-8458
+1-651-681-7600
www.ergotron.com
sales@ergotron.com

EMEA Sales

Amersfoort, The Netherlands
+31 33 45 45 600
www.ergotron.com
info.eu@ergotron.com

APAC Sale

Tokyo, Japan
www.ergotron.com
apaccustomerservice@ergotron.com

Worldwide OEM Sales

www.ergotron.com
info.oem@ergotron.com

