

Ergotron® LX

Dual Stacking Arm

Dimensional & Range of Motion Illustrations

Dimensions

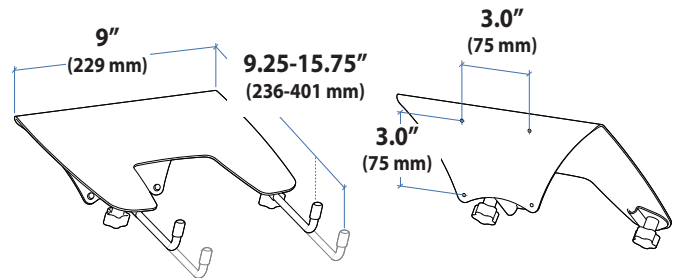
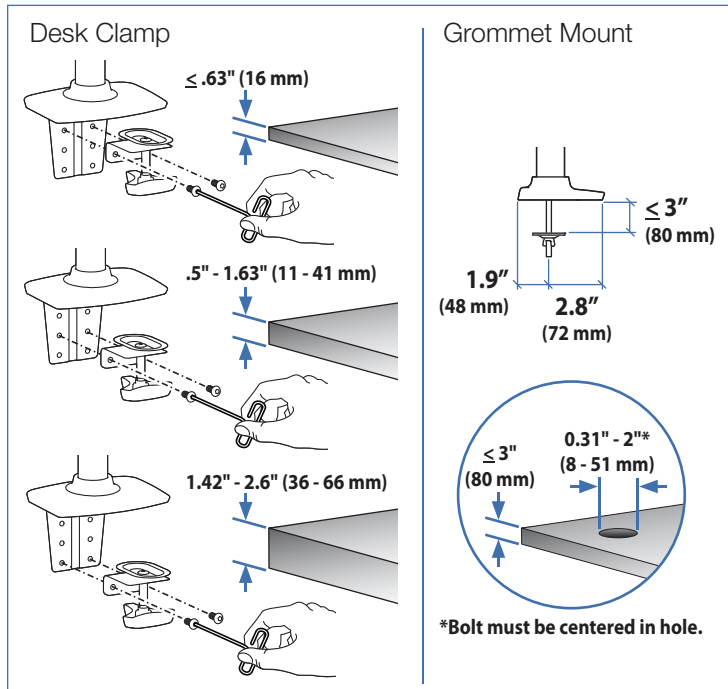
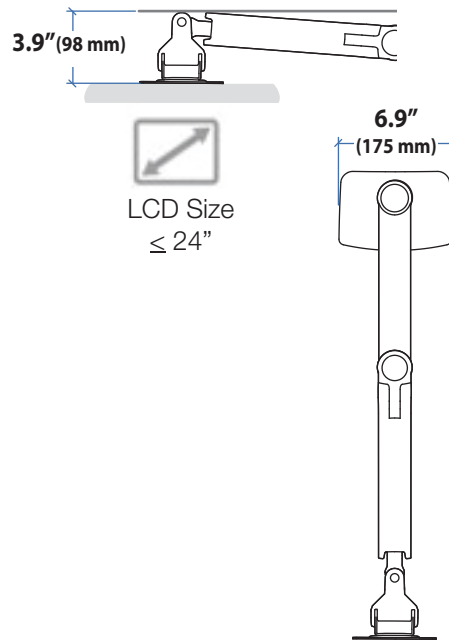
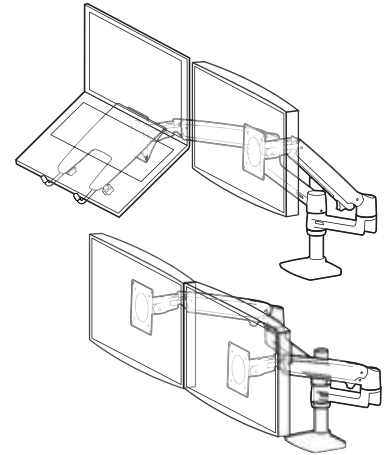
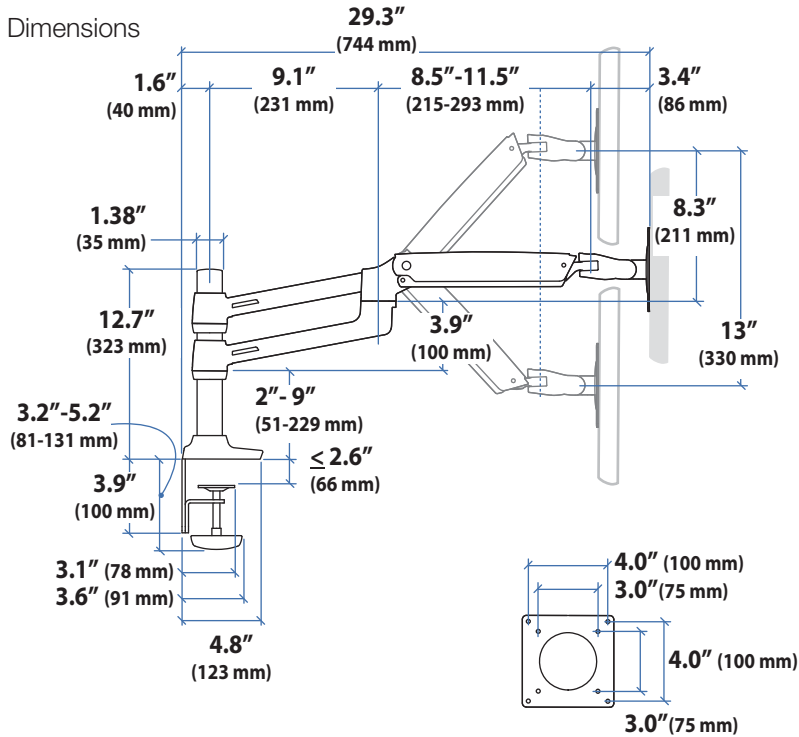

© 2013 Ergotron, Inc. rev. 06/04/2013 DIM2-062 Content is subject to change without notification

Americas Sales and Corporate Headquarters
 St. Paul, MN USA
 (800) 888-8458
 +1-651-681-7600
 www.ergotron.com
 sales@ergotron.com

EMEA Sales
 Amersfoort, The Netherlands
 +31 33 45 45 600
 www.ergotron.com
 info.eu@ergotron.com

APAC Sale
 Tokyo, Japan
 www.ergotron.com
 apaccustomerservice@ergotron.com

Worldwide OEM Sales
 www.ergotron.com
 info.oem@ergotron.com



Ergotron® LX

Dual Stacking Arm

Dimensional & Range of Motion Illustrations

Range of Motion

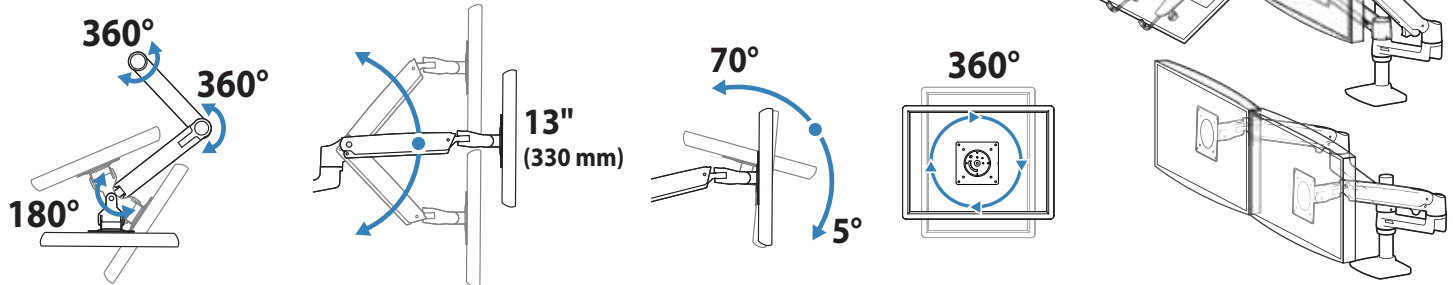

Weight Capacity

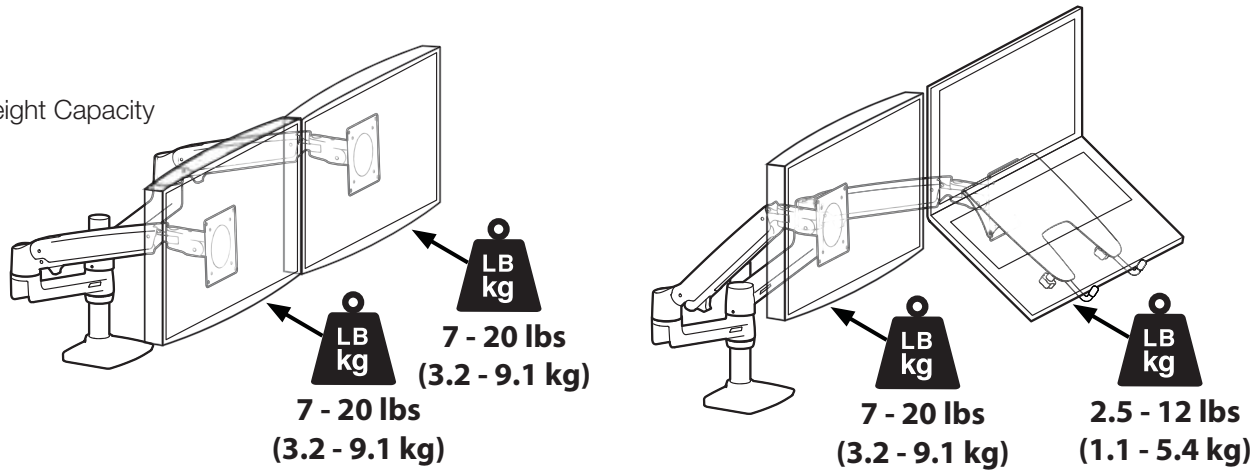

Monitor depth greater than 2.5" (64 mm) may diminish capacity. Call Ergotron for more information.

© 2013 Ergotron, Inc. rev. 06/04/2013 DIM2-062 Content is subject to change without notification

Americas Sales and Corporate Headquarters

St. Paul, MN USA
(800) 888-8458
+1-651-681-7600
www.ergotron.com
sales@ergotron.com

EMEA Sales

Amersfoort, The Netherlands
+31 33 45 45 600
www.ergotron.com
info.eu@ergotron.com

APAC Sale

Tokyo, Japan
www.ergotron.com
apaccustomerservice@ergotron.com

Worldwide OEM Sales

www.ergotron.com
info.oem@ergotron.com

